

# Gardenside

PREMIUM TEAK FURNITURE

GARDENSIDE LTD.  
808 ANTHONY ST.  
BERKELEY, CA 94710  
1-888-999-TEAK  
PHONE: (415) 455-4500  
FAX: (415) 455-4505  
www.gardenside.com

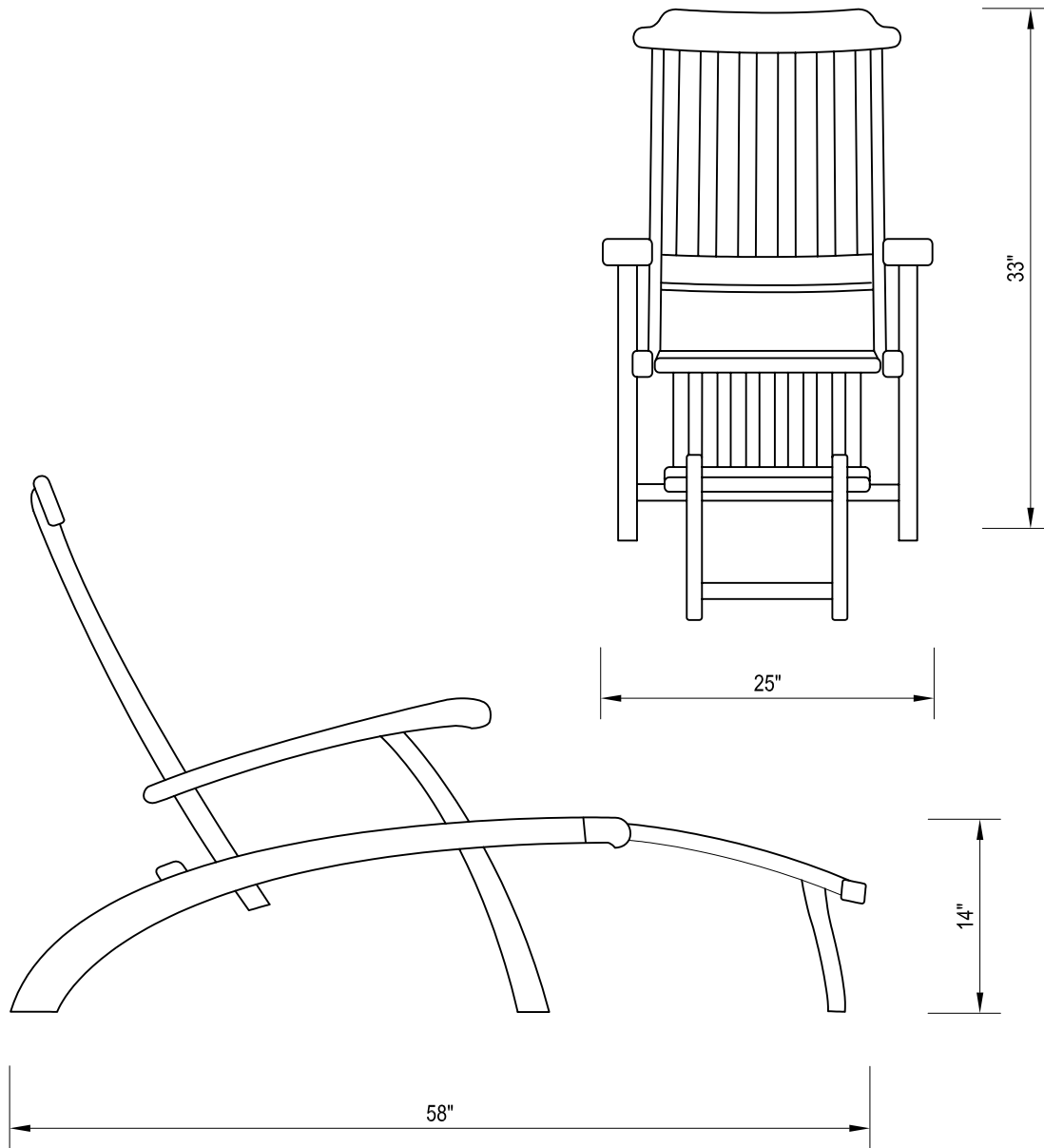

**NOTES:**

1. INSTALLATION TO BE COMPLETED IN ACCORDANCE WITH MANUFACTURER'S SPECIFICATIONS.
2. DO NOT SCALE DRAWINGS.
3. CONTRACTORS NOTE: FOR COMPANY AND PRODUCT INFORMATION VISIT [www.CADdetails.com/info](http://www.CADdetails.com/info) REFERENCE NUMBER 716-079.

