

Gardenside

PREMIUM TEAK FURNITURE

GARDENSIDE LTD.
808 ANTHONY ST.
BERKELEY, CA 94710
1-888-999-TEAK
PHONE: (415) 455-4500
FAX: (415) 455-4505
www.gardenside.com

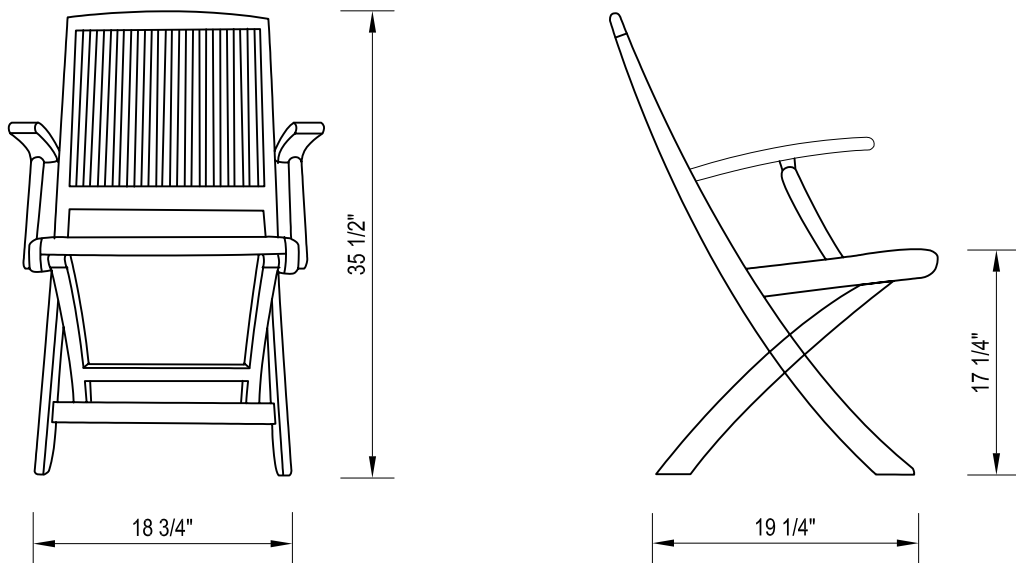

NOTES:

1. INSTALLATION TO BE COMPLETED IN ACCORDANCE WITH MANUFACTURER'S SPECIFICATIONS.
2. DO NOT SCALE DRAWINGS.
3. CONTRACTORS NOTE: FOR COMPANY AND PRODUCT INFORMATION VISIT www.CADdetails.com/info REFERENCE NUMBER 716-057.

